

IM 130

VERTICAL CENTRIFUGAL PUMPS

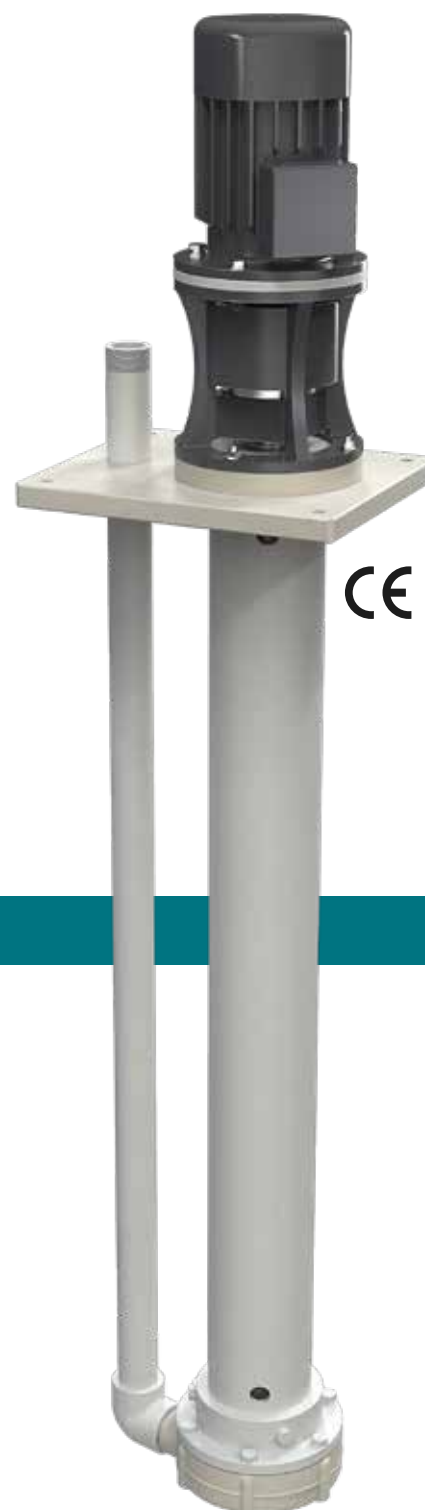

- Product designed and constructed in Italy
- Constructed in polypropylene or PVDF
- Normalised electric motor
- Support lantern and connection between pump and motor with a flexible coupling
- Usable with fluids containing suspended solids
- Suitable for continuous use

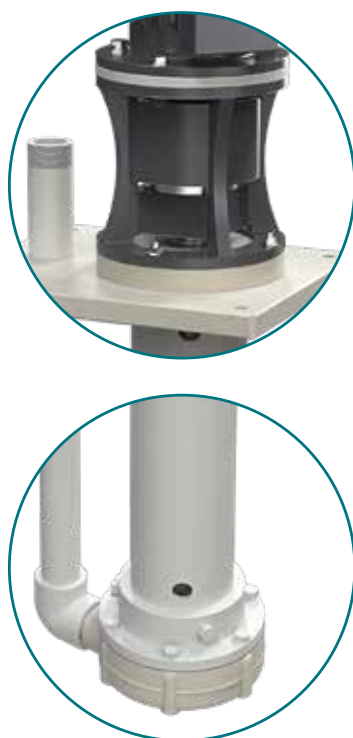

IM PUMPS CODES ENCODING

ex.IM140P-V-0800-N
IM140 PP, O-Ring Viton®, column height 800 mm, three-phase motor

IM140	P	V	0800	N
PUMP MODEL	PUMP PUMP	O-RING	COLUMN HEIGHT	MOTOR
IM 80 - IM 80 IM 90 - IM 90 IM 95 - IM 95 IM 110 - IM 110 IM 120 - IM 120 IM 130 - IM 130 IM 140 - IM 140 IM 150 - IM 150 IM 155 - IM 155 IM 160 - IM 160 IM 180 - IM 180 IM 200 - IM 200	P - Polypropylene FC - PVDF+CF	D - EPDM V - Viton®	0250 - 250 mm** 0500 - 500 mm 0800 - 800 mm 1000 - 1000 mm 1250 - 1250 mm	N* - Three-phase motor M - Single-phase motor A - ATEX motor

* Three-phase asynchronous eurotension motor fitted as standard (2 poles) 50Hz

** Available only for IM 80/90 pumps

IM 130

VERTICAL CENTRIFUGAL PUMPS



Specifications and types

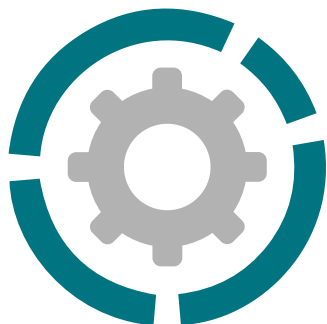

Suction fittings	G 2" m or DN 50 on request
Delivery fittings	G 1"1/2 m or DN 40 on request
Max flow rate	30 m ³ /h
Max head	20 m
Viscosity up to	500 cps
Standard open impeller	Ø 130 mm H 8 mm *
Passing solids	Ø max 6 mm

* Special versions are available on request for the fluid pumped

PP



PVDF



Standard electric motor:

Kw	2.2
HP	3
Box	B5
RPM	2900

THREE-PHASE 230/400 V
50/60 Hz

2 poles

Efficiency class IE3

IP55 protection rating

Ambient temperature -30°C + 45°C

Aluminium/Cast iron

SINGLE-PHASE on request

ATEX on request

STD Column length	PP* weight	PVDF* weight
500	15 kg	16 kg
800	19 kg	20 kg
1000	22 kg	23 kg
1250	24 kg	25 kg

* The weights refer to the pump without the motor

NB: Special versions only on request with column length from min. 350 mm to max. 1400 mm.

MAIN APPLICATION SECTORS



CHEMICAL
INDUSTRY



WATER AND SLUDGE
TREATMENT



GALVANIC AND ELECTRONIC
INDUSTRY



GOLD PROCESSING
INDUSTRY

Operating temperature:

PP	from +3°C to +65°C
PVDF	from +3°C to +95°C

Specifications and types

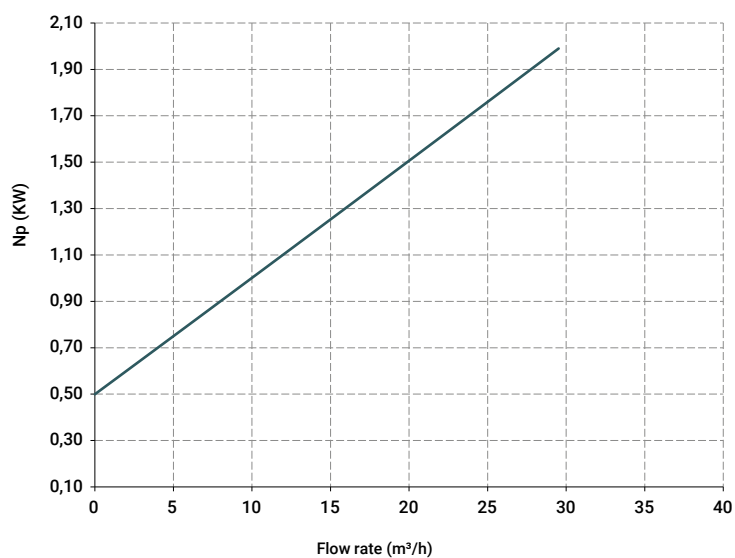
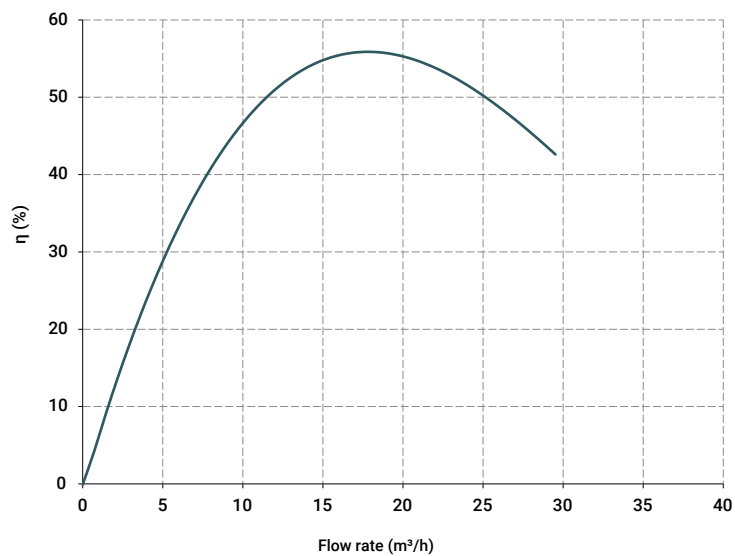
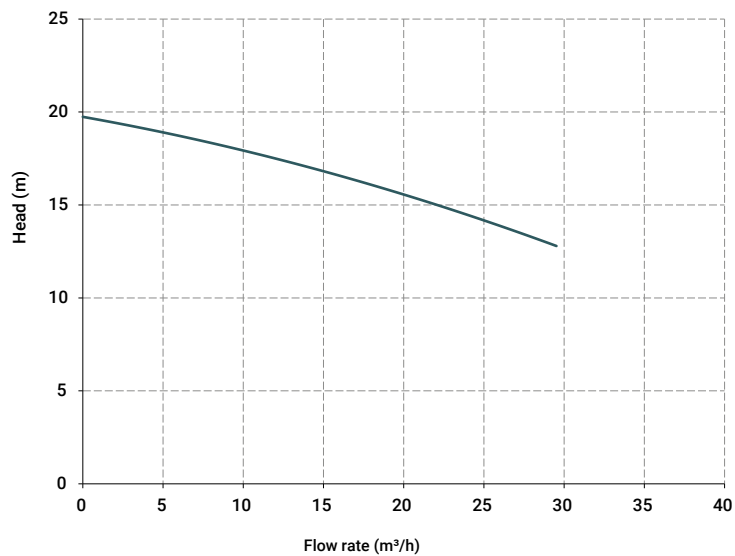

The curves and the performances refer to pumps with open delivery outlet, with water at 20°C, 50 Hz two-pole motor [2900 RPM].

IM 130

VERTICAL CENTRIFUGAL PUMPS



Specifications and types

MODEL	POWER	ØPASSING SOLIDS	A	B	C	D	E	F	G	H	I	M	N	O	P	KG MOTOR
IM 130	2.2 Kw - 3 HP	6	467	220	25	125	360	135	165	60	300	310	165	250	Ø203	20

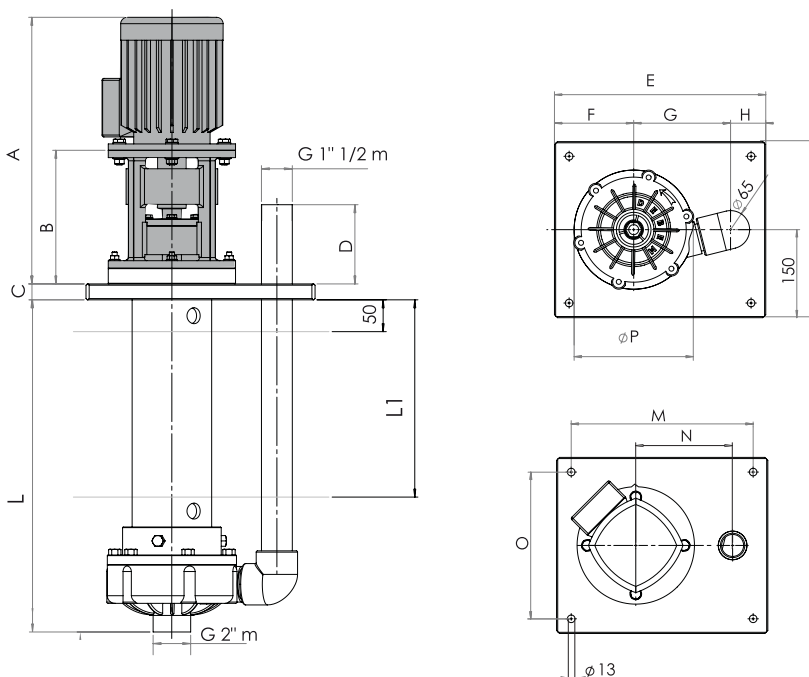

TANK USE

Pump	Motor power
IM 80	0.37 Kw - 0.5 HP
IM 90	0.55 Kw - 0.75 HP
IM 95	0.75 Kw - 1 HP
IM 110	1.1 Kw - 1.5 HP
IM 120	1.5 Kw - 2 HP
IM 130	2.2 Kw - 3 HP
IM 140	3 Kw - 4 HP
IM 150	4 Kw - 5.5 HP
IM 155	5.5 Kw - 7.5 HP
IM 160	7.5 Kw - 10 HP
IM 180	11 Kw - 15 HP
IM 200	18.5 Kw - 25 HP

Seal o-ring materials:

- EPDM
- VITON®

Package:

wooden cage - weights and dimensions vary based on the length of the pump

Accessories

FLANGE KIT (DIN standard - ANSI available on request):

- KITFLANGIM130P (POLYPROPYLENE)
- KITFLANGIM130F (PVDF)

- Pump protection filter* in PP (*the filter is sold separately)
- Pump protection filter* in PVDF (*the filter is sold separately)

Customisable fixing plate only at the design stage